



Emerging Technologies Summit

MAKING THE CONNECTION:
From Energy Efficiency Innovation to Delivery

April 19 – 21, 2017

Combining Forces: Next Generation Space Conditioning and Water Heating Equipment

KIM ERICKSON, PAUL GLANVILLE, CHARLIE STEPHENS, RYAN KERR, SCOTT REED, JOHN MILES, CHERIF YOUSSEF



Drivers

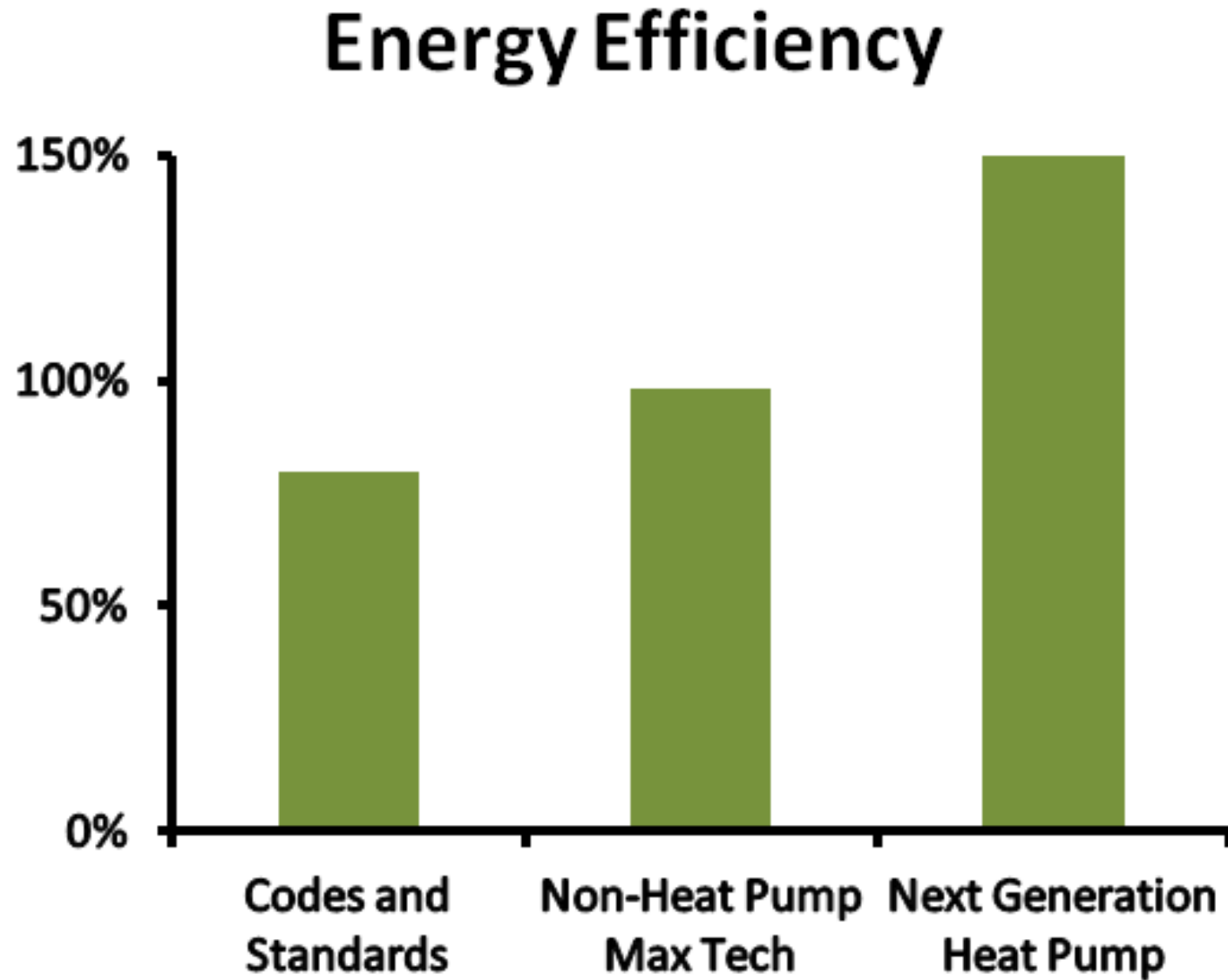

Drivers

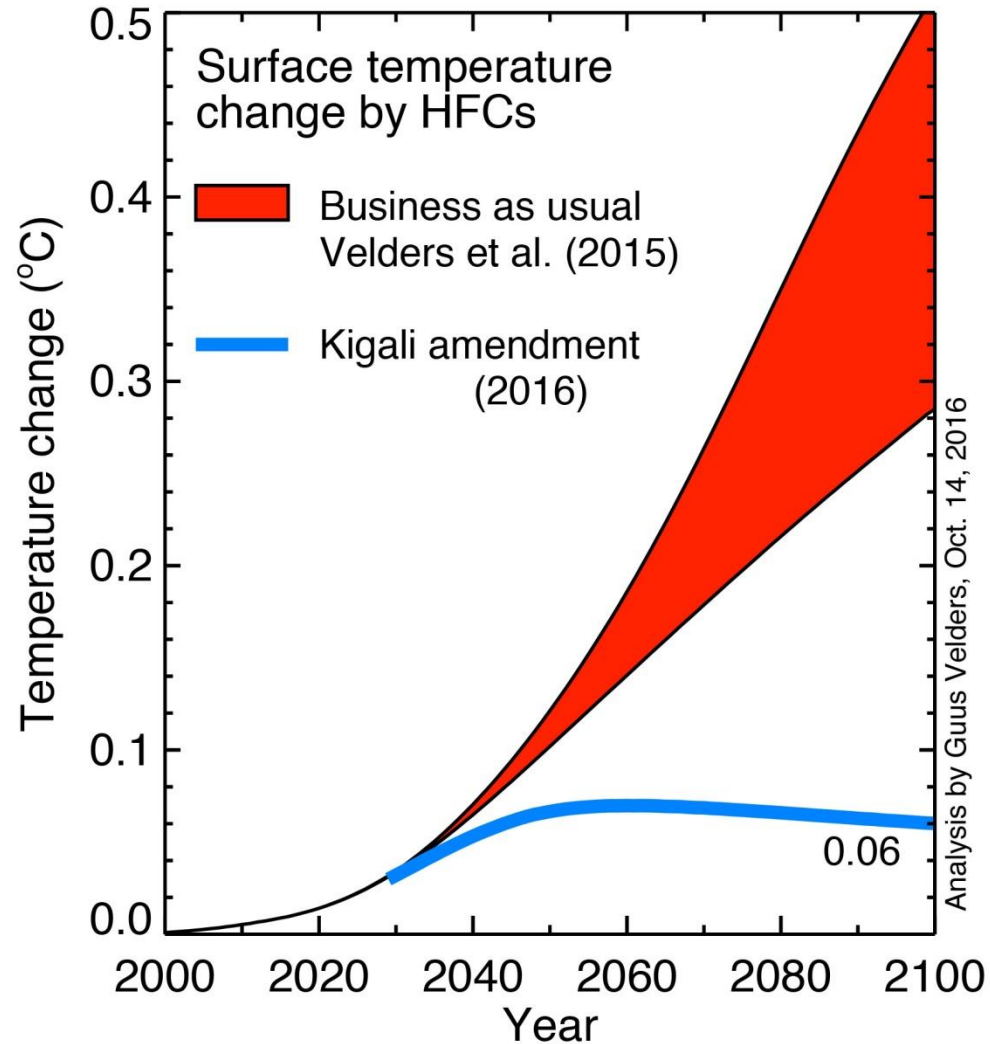

Greenhouse Gas Reduction HFC Phase Out

Source: National Oceanic and
Atmospheric Administration
https://www.esrl.noaa.gov/csd/news/2016/images/196_1016.jpg



Drivers

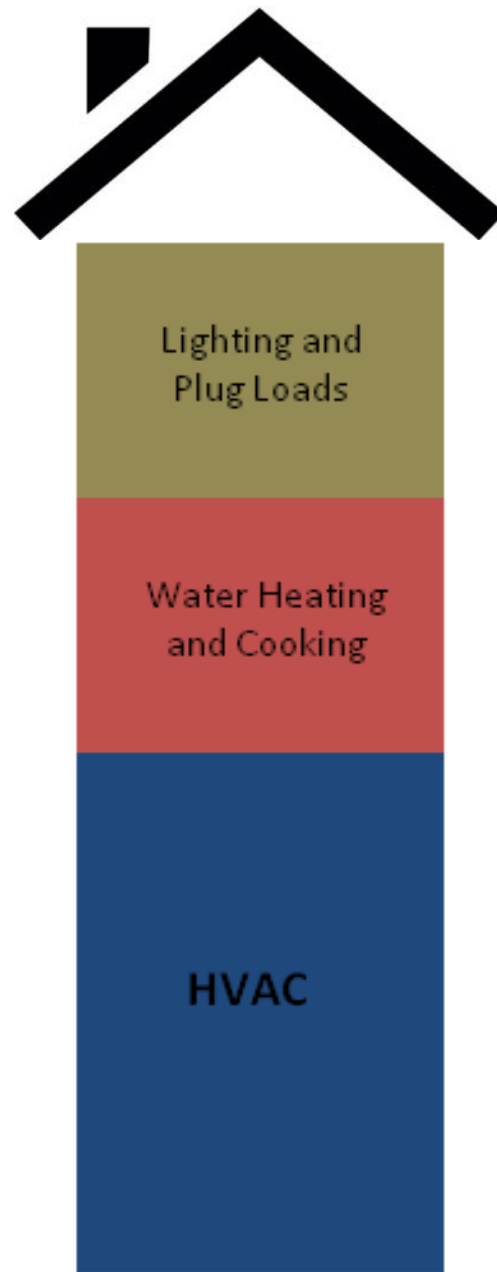

Path to Zero Net Energy

Low Load Homes

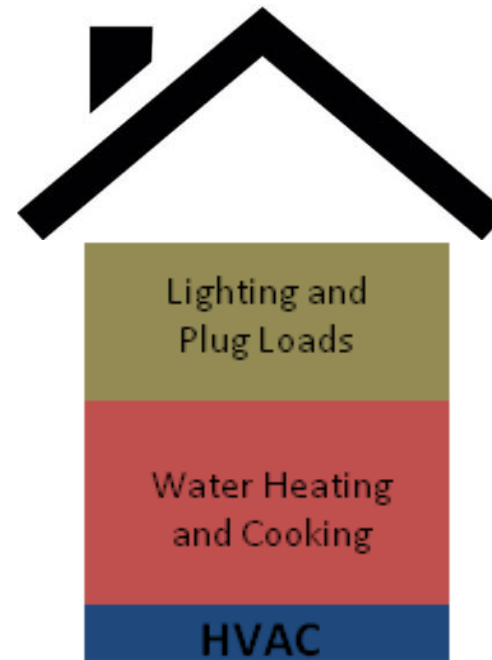

Energy Efficiency Program Drivers

Drive down cost
per unit saved

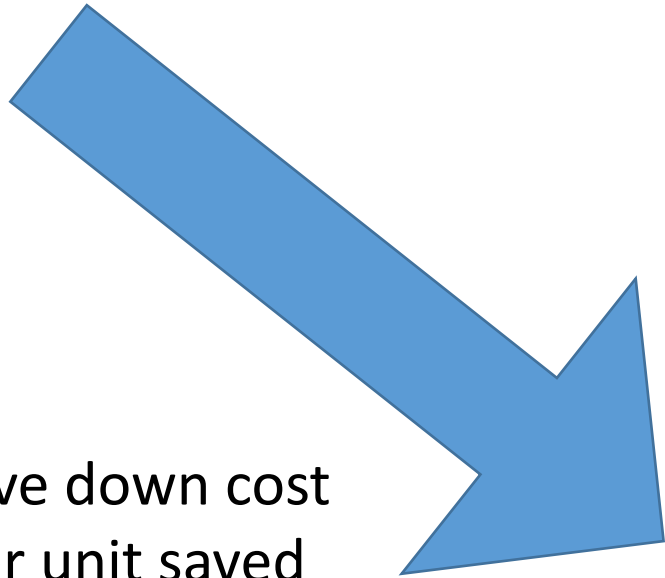

Grid reliability
Energy storage



Greater savings
through a
bundled measure



Agenda

- Opportunity Overviews (40 minutes)
 - Gas absorption heat pumps: Paul Glanville, Gas Technology Institute
 - CO2 heat pumps: Charlie Stephens, Northwest Energy Efficiency Alliance
 - Low load furnaces: Ryan Kerr, Gas Technology Institute
- Small Group Discussion (30 minutes)
 - Gas absorption heat pumps: Scott Reed, SMTI
 - CO2 heat pumps: John Miles, Sanden
 - Low load furnaces: Cherif Youssef, SoCalGas
- Report Out and Wrap Up (15 minutes)





Emerging Technologies Summit

Overview of Gas-Fired Absorption Heat Pumps: Combination Space/Water Heating

Paul Glanville, PE
Gas Technology Institute

2017 ET Summit
April 20th, 2017



GTI Overview

- > Independent, not-for-profit established by the natural gas industry
- > Providing natural gas research, development and technology deployment services to industry and government clients
- > GTI tackles tough energy challenges turning raw technology into practical solutions
- > Downhole to the burner tip including energy conversion technologies

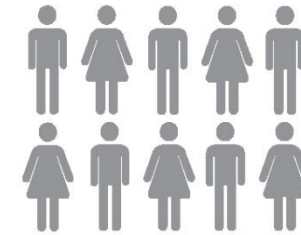

Transforming Residential Heating

Heating in US: Target for Energy/GHG Savings

- > Natural gas consumed to heat homes is 29.5 billion therms:
 - 63% of total res. gas consumption, greater if > 5,000 HDD
 - 29% of res. site energy, **largest end use of site energy** > site electricity for (HVAC + water heating + refrigeration)
 - Resulting in 156 MMTCO₂e/year

California Focus:

- > Gas heating in 65% of homes and gas DHW in 75% of homes, versus ~50% average in US
- > Homes served by CA IOUs consume 2.7 billion therms/yr for heating/DHW, resulting in 15 MMTCO₂e/year emitted
 - GHG impact equivalent to 35 billion VMT for light-duty vehicles

Residential Gas Consumption: Regional breakdown of total consumption (billion therms):

- **Space Heating**
- **Water Heating**
- **Other (drying, cooking, etc.)**

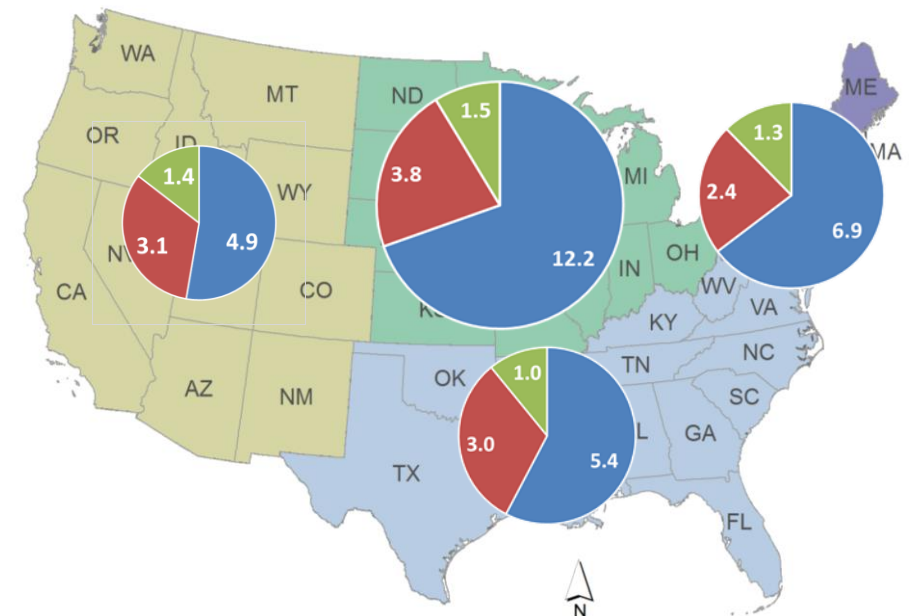

Gas Absorption Heat Pumps: Key Definitions

- > **Heat Pump:** HVAC equipment that moves heat from cold source to warm sink, moving heat “uphill”
 - Many operate reversibly, providing A/C as well
 - With heat recovery, can provide domestic hot water (DHW) too
- > **Gas Heat Pump:** Instead of electric compressor, GHPs use gaseous fuels as primary drive energy
 - GHPs can be based on several thermodynamic cycles, including vapor compression
 - Gas cooling feasible but not always economical



Gas Absorption Heat Pumps - Basics

> Gas Absorption Heat Pumps (GAHP) are based on the *vapor absorption cycle*

- Heat Pump*:
- HSPF 8.0 (EnergyStar)
 - $COP_{site} = 3.8$
 - $COP_{source} = 1.2$ (US)
 - $COP_{source} = 1.3$ (CA)

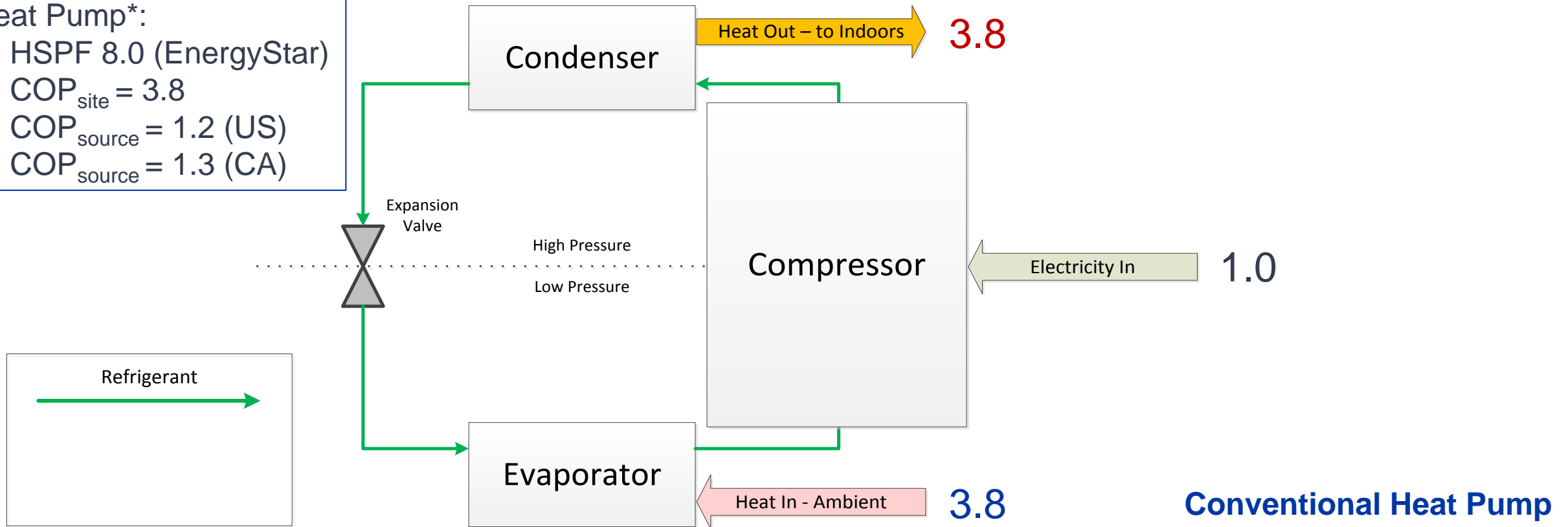

Gas Absorption Heat Pumps - Basics

> Gas Absorption Heat Pumps (GAHP) are based on the *vapor absorption cycle*

- Heat Pump*:
- AFUE 140%
 - $COP_{site} = 1.5$
 - $COP_{source} = 1.4$ (US)
 - $COP_{source} = 1.4$ (CA)

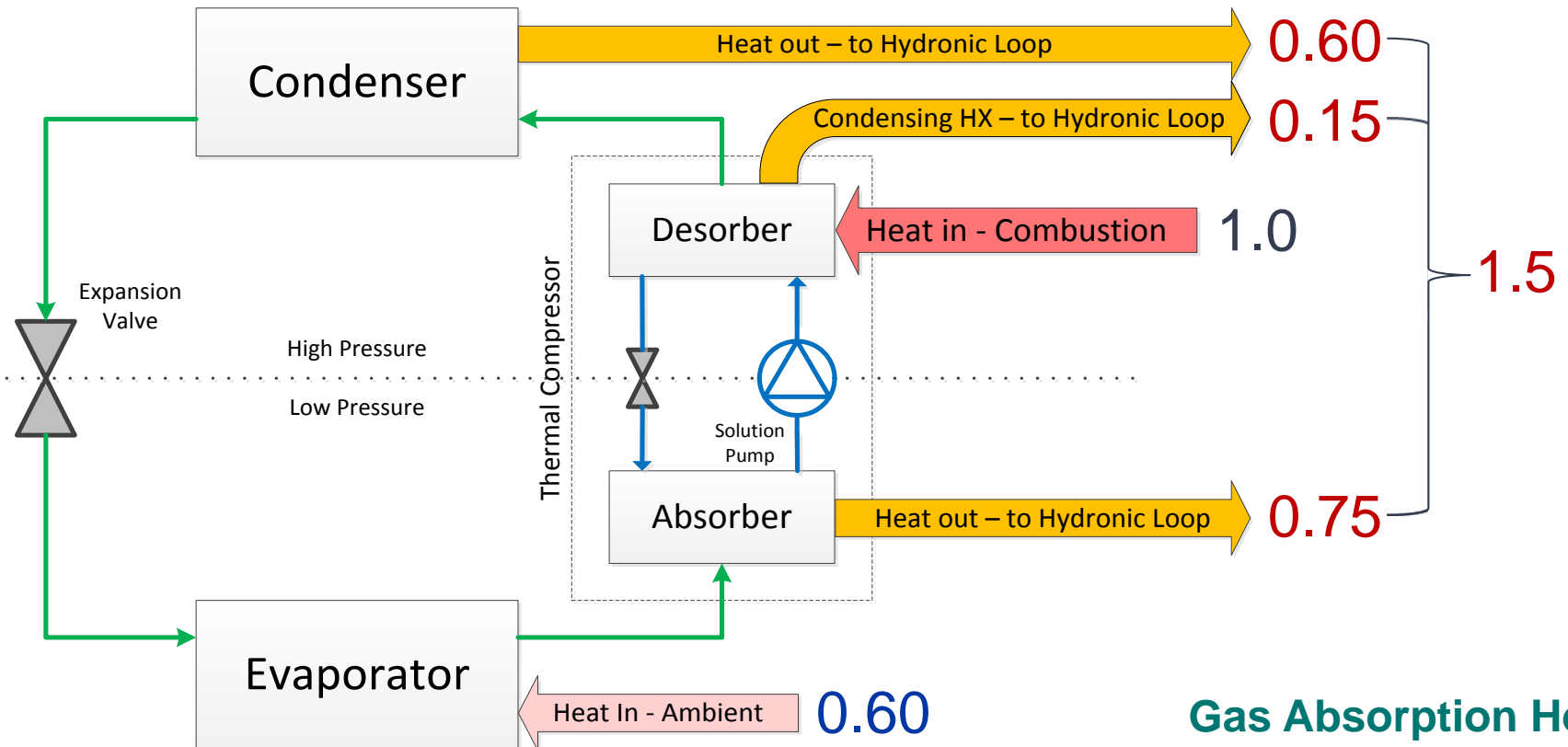
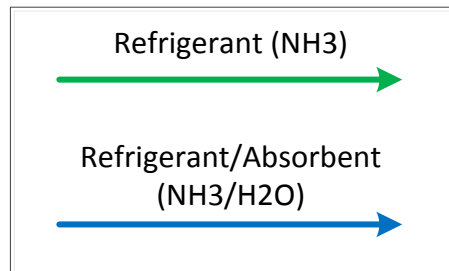

Gas Absorption Heat Pump

Gas Absorption Heat Pumps: Basics

- > High-efficiency heating -140% AFUE demonstrated for single-effect GAHPs, simplest form of tech.
- > Absorption is mature technology, common for large chillers worldwide (LiBr-H₂O) and emerging for domestic combi heating in markets overseas
 - GAHPs treated as renewable in EU, with A++ rating
 - EU, like US, striving for “beyond condensing”
- > Residential GAHPs available in EU from single supplier, branded and packaged by other mfrs.
 - Larger HVAC OEMs planning to introduce GAHPs in next two years



GAHPs commercially available in EU for home heating, in 2016 an 18 kW (61 MBH) output released by Italian mfr. Unit costs are prohibitive for US, > \$11,000 (excl. shipment)

Low-Cost Gas Absorption Heat Pump

Direct-fired NH₃-H₂O single-effect absorption cycle with integrated heat recovery. Can link with a hydronic air handler for forced-air space heating and indirect-fired storage tank for combination space/water heating. Development team led by startup company with support from GTI and manufacturing partners.



	GAHP	Units/Notes
Heat Pump Output	80,000 (23)	Btu/hr (kW) with 4:1 modulation
Firing Rate	55,000 (16)	Btu/hr (kW)
Target Efficiency	COP > 1.4 at 47°F 140% AFUE	Based on GTI Lab/Field Testing
Emissions (projected)	14 ng NO _x /J (50 mg NO _x /kWh)	
Installation	Outdoors	Like boiler, hydronic heating to radiators, in-floor, or forced-air
Venting	N/A	Outdoors
Gas Piping	3/4"	
Refrigerant Charge	< 0.2	kg/kW heating
	0.0 ODP, 0.0 GWP	
Estimated Unit Cost	Competitive with condensing boilers	

Low-Cost GAHP: Laboratory Performance

GAHP Comparative Results – Prototype Units 1/2

- > Compare lab results of prototype units to EU GAHP, benefits of SE design, 139% AFUE confirmed
 - Note $GUE = COP_{Gas}$ with LHV and $47\text{ F} = 8.3\text{ C}$
- > Comparing to cold climate ASHP, GAHP performs well on source basis with *no backup heating*

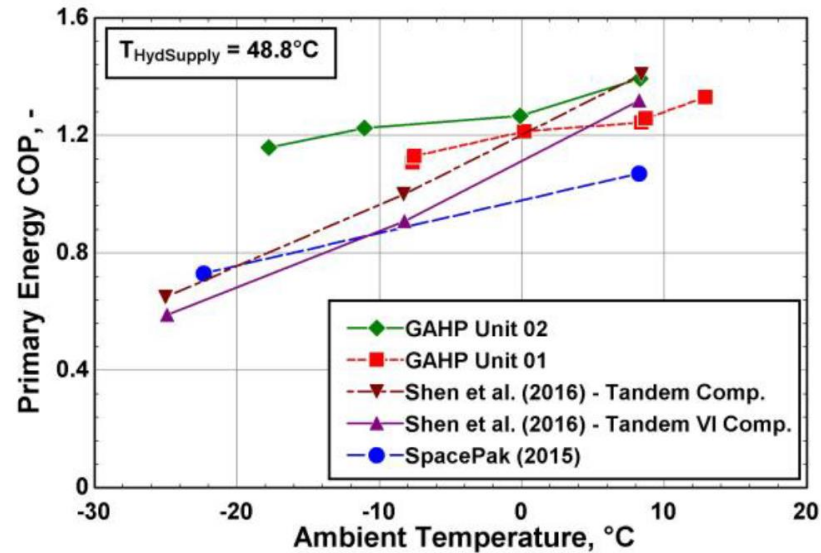
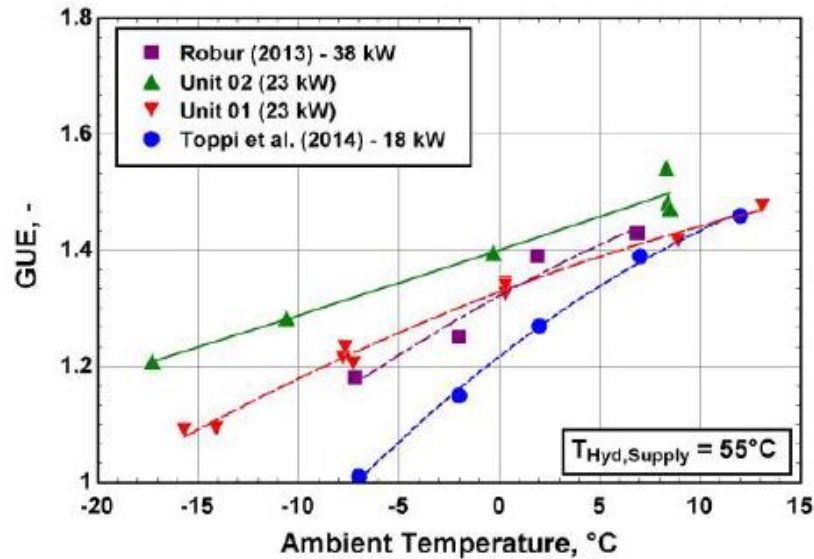

Low-Cost GAHP: Field Performance

- > GTI and partners performing field assessment of two GAHPs in Eastern TN: Residential Combi and Commercial Space Heating applications
- > GAHP as Commercial Water Heater demonstrations planned for 2017 and 2018 with GTI and ORNL
- > Proposed expanded GAHP combi demonstration incorporating lessons learned for 2017-18 heating season.

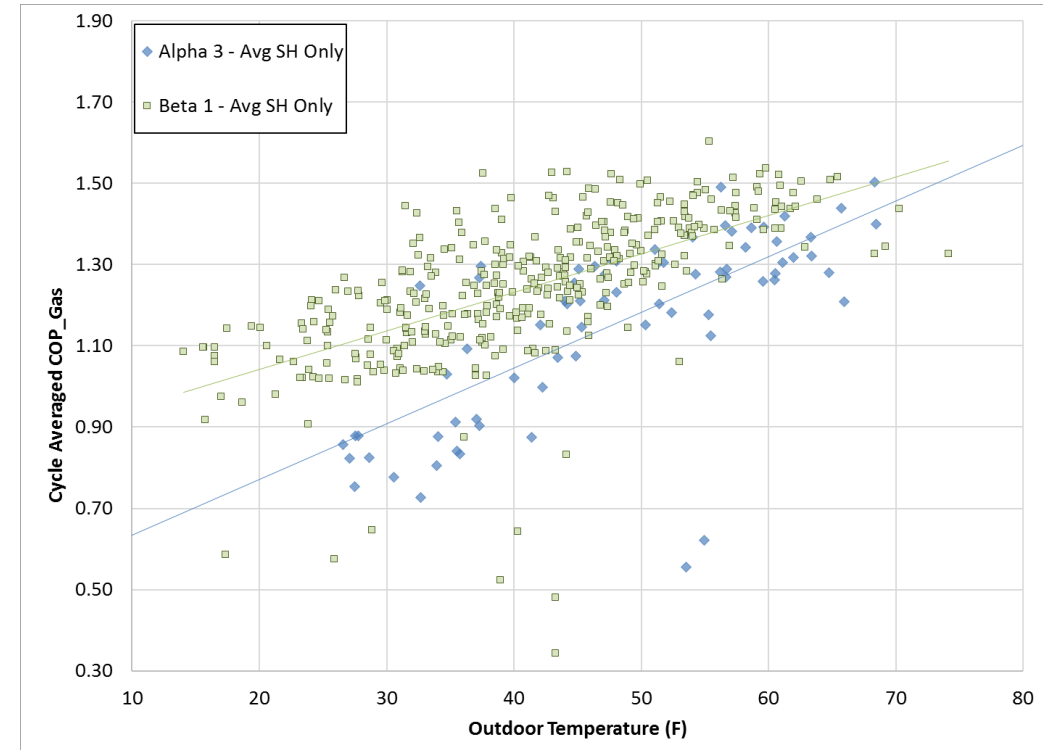

Data from GAHP Combi Sites highlighting improvement from new generation prototype

Low-Cost GAHP: Benefits

- > **Efficiency:** With projected 140% AFUE, GAHP combi system may yield therm savings of up to 45%. System modulation 4:1 permits load following
- > **Reliability:** GAHPs do not require backup heating, can continue operation without interruption during defrost
- > **Emissions/Combustion Safety:** With projected AQMD compliance, NOx and GHG emissions are decreased by up to half and all combustion occurs outdoors
- > **Climate:** GAHPs use natural refrigerant/absorbent pairs with 0.0 GWP/ODP
- > **Zero Net Energy:** With greater benefit in colder climates, GAHPs can reduce source energy burden in mixed ZNE homes, lower cost ZNE buildings*



Experimenting with Defrost Control at Field Site

Low-Cost GAHP: Benefits

- > **Flexibility:** Core technology demonstrated to scale from 10-140 kBtu/hr output, product family can be sized for range of single/multifamily combi heating applications
 - Low-Cost GAHP development followed gas heat pump water heater development for 10 kBtu/hr output heat pump
 - GAHPs can operate in hybrid arrangement in series with conventional gas heating for high output applications
 - Flexible with forced-air, in-floor, baseboard, zoned, or other heating configurations
 - Note that GAHP prototypes were not designed to deliver above 160 F supply temperatures



Gas HPWH operating at field site in 2017

Low-Cost GAHP: Challenges

- > As a combi system, the GAHP combi deployment may overcome traditional Combi System issues:
 - Improved comfort, as **GAHP will have longer runtimes** due to “higher mass”, steadier system operation
 - With storage, system may better **assure DHW priority** while maintaining comfort and **assure Legionella control**
- > However as a combi system, it may face some of the same challenges such as:
 - Contractor challenges with training, crossing of trades (HVAC + Plumbing), **excessive premiums for installations**
 - **Majority are field-engineered**, many installed without proper controls/fan coil sizing for high performance
 - Cost of components, including **fan coil and indirect tank**

- > As an emerging tech., the GAHP may struggle with:
 - **Complexity of installation**, with hydronic lines running from outdoors to heating loop – most homes have forced-air. Manufacturers may standardize installation kits, like EHPs
 - Complexity of programs, **no longer one-size-fits-all** like furnaces – savings depend on climate zone, etc., like EHPs

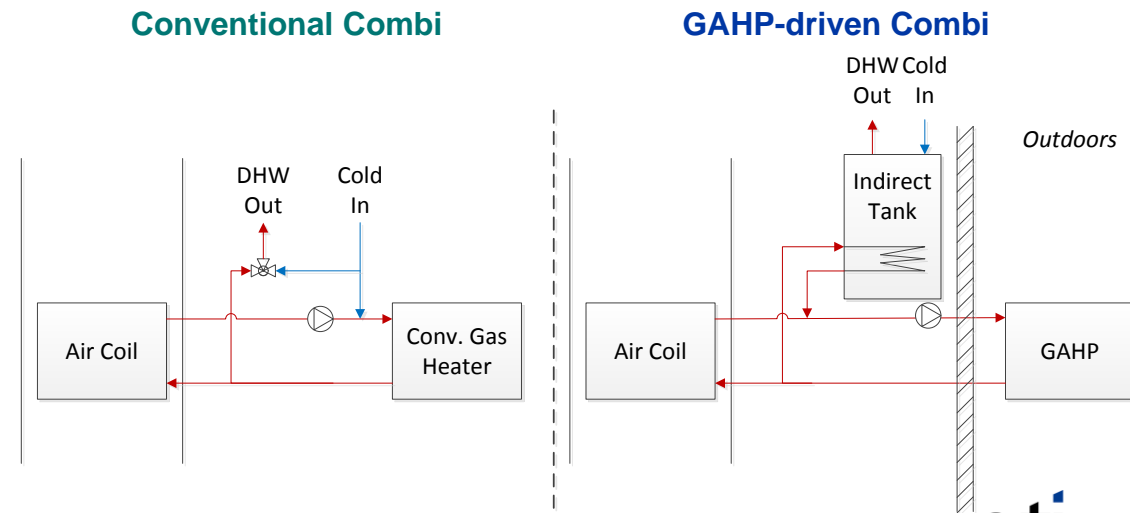

Questions?

Further information:

Paul.glanville@gastechnology.org

RD&D Discussed Supported by:



U.S. DEPARTMENT OF ENERGY



Gas Technology Institute

1700 S Mount Prospect Rd,
Des Plaines, IL 60018, USA

www.gastechnology.org



<http://www.stonemounttechnologies.com/>

April 21st, 2017



CO₂ Heat Pumps: A Technology Primer

Charlie Stephens
ET Summit - 2017



Why CO₂ (or other natural refrigerant)?

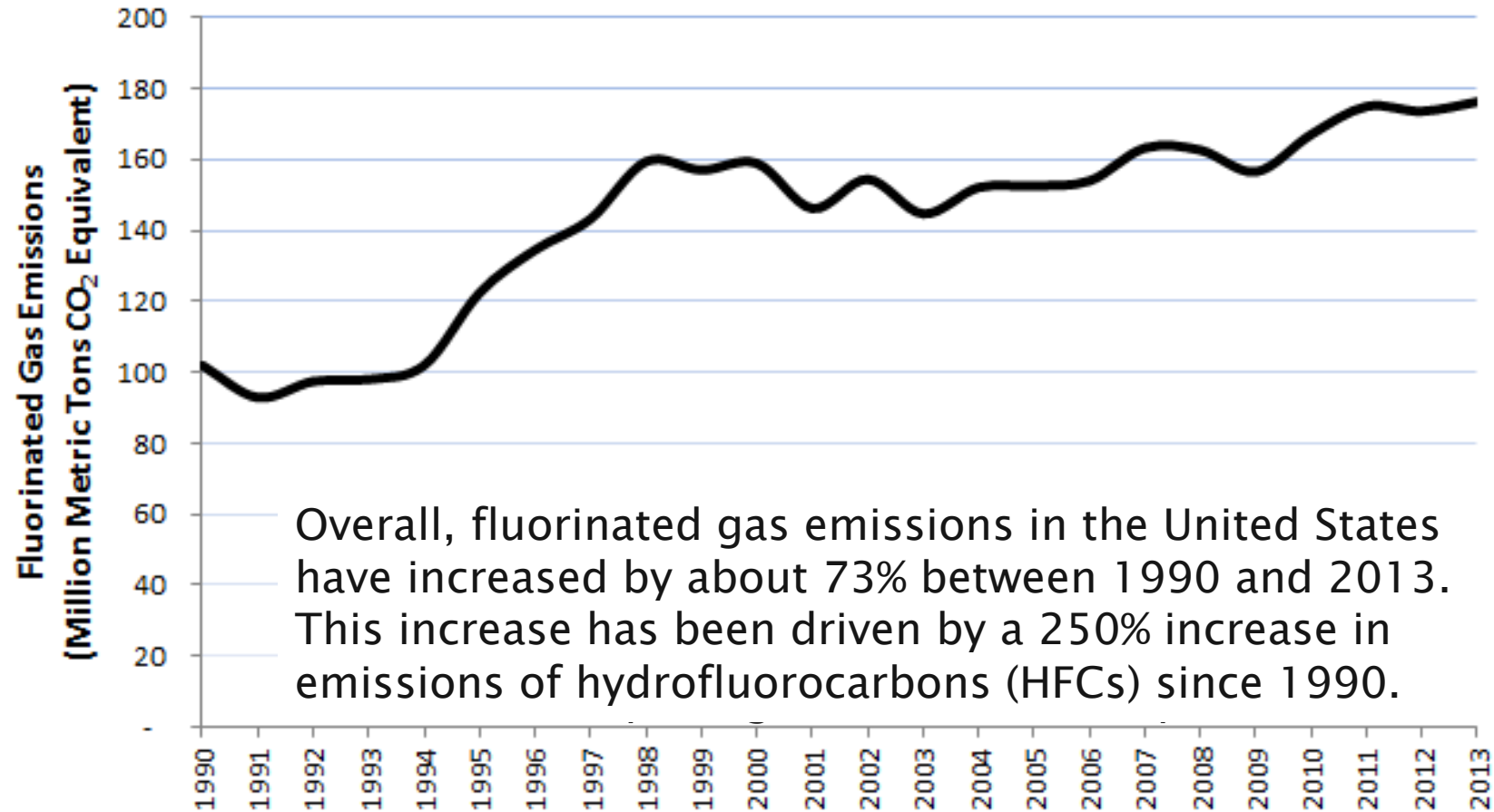

Phase-outs are Imminent

- Kigali has accelerated the North American phase-out schedule. It now begins in 2018 and must be 85% complete by 2036. Treaty is binding.
- Europe is phasing out HFC refrigerants now
 - Depending on end use, phase-out will occur from 2017 through 2022.
 - Many manufacturers (automotive, commercial refrigeration) are choosing CO₂ as their new refrigerant.
- U.S. is a couple of years behind Europe
 - But some markets are moving now (e.g. CARB proposal for R-410a phase-out in 2021, Whole Foods).



Refrigerant GWPs

- R-410a (small hvac, HPWH): 2,030
(CARB proposes banning in new systems in 2021)
- R-134a (auto AC, ref/frzrs, HPWH): 1,430
(Banned in auto A/C, vending machines as of 2016)
- R-404a (groc. & conv. store refriger.): 3,920
(Banned in new systems as of January 2017)
- R-507a (commercial refrigeration): 3,990
- R-32 (proposed replacement for R-410a): 675
(Daikin owns the patents)
- R-290 (Propane; refrigeration): 3
- R-744 (CO₂; auto AC, hvac, refriger., HPWH) 1

Relevant End Use Equipment

- Water heating (air-to-water heat pump, R-744)
- Space heating (air-to-water heat pump, R-744)
- Grocery store refrigeration (packaged and rack-based; R-290, R-744; cascade systems using more than one refrigerant, including ammonia)
- Vending machines (R-744, R-290, R-600a)

Trans-critical Point

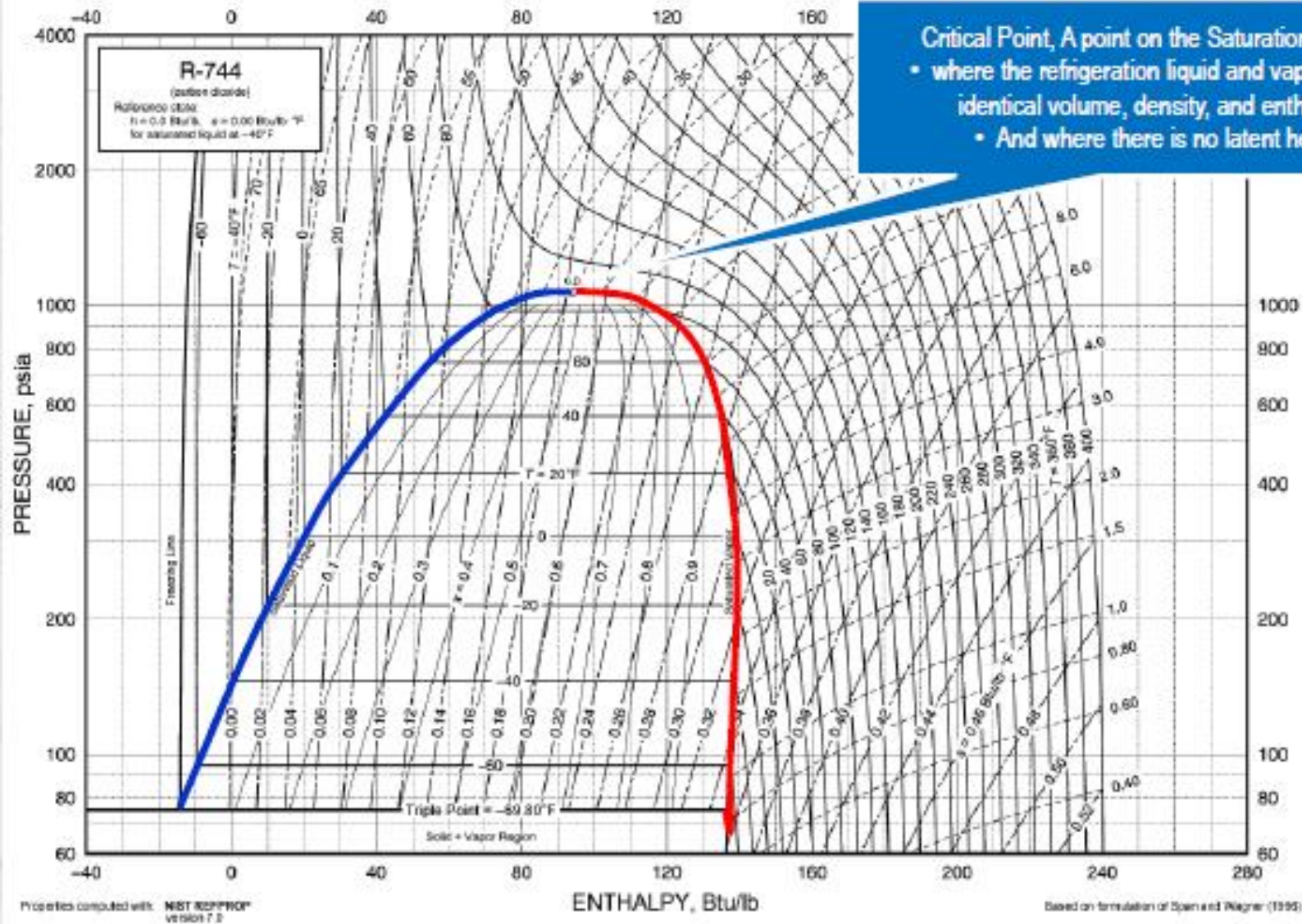

Critical Point, A point on the Saturation Curve:

- where the refrigeration liquid and vapour have identical volume, density, and enthalpy
- And where there is no latent heat

2009 ASHRAE Handbook—Fundamentals

Fig. 18 Pressure-Enthalpy Diagram for Refrigerant 744 (Carbon Dioxide)

Sub-critical Cycle

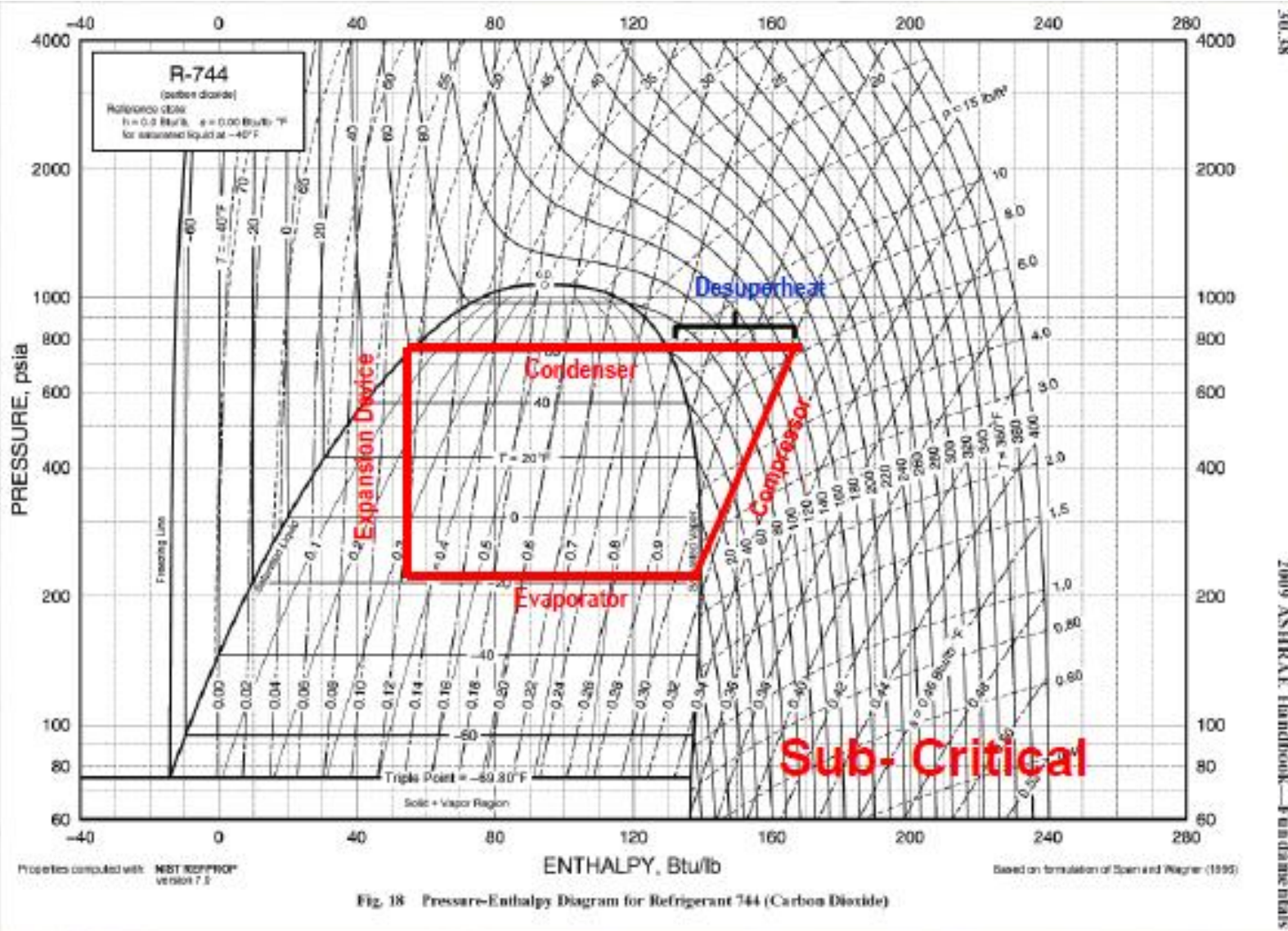
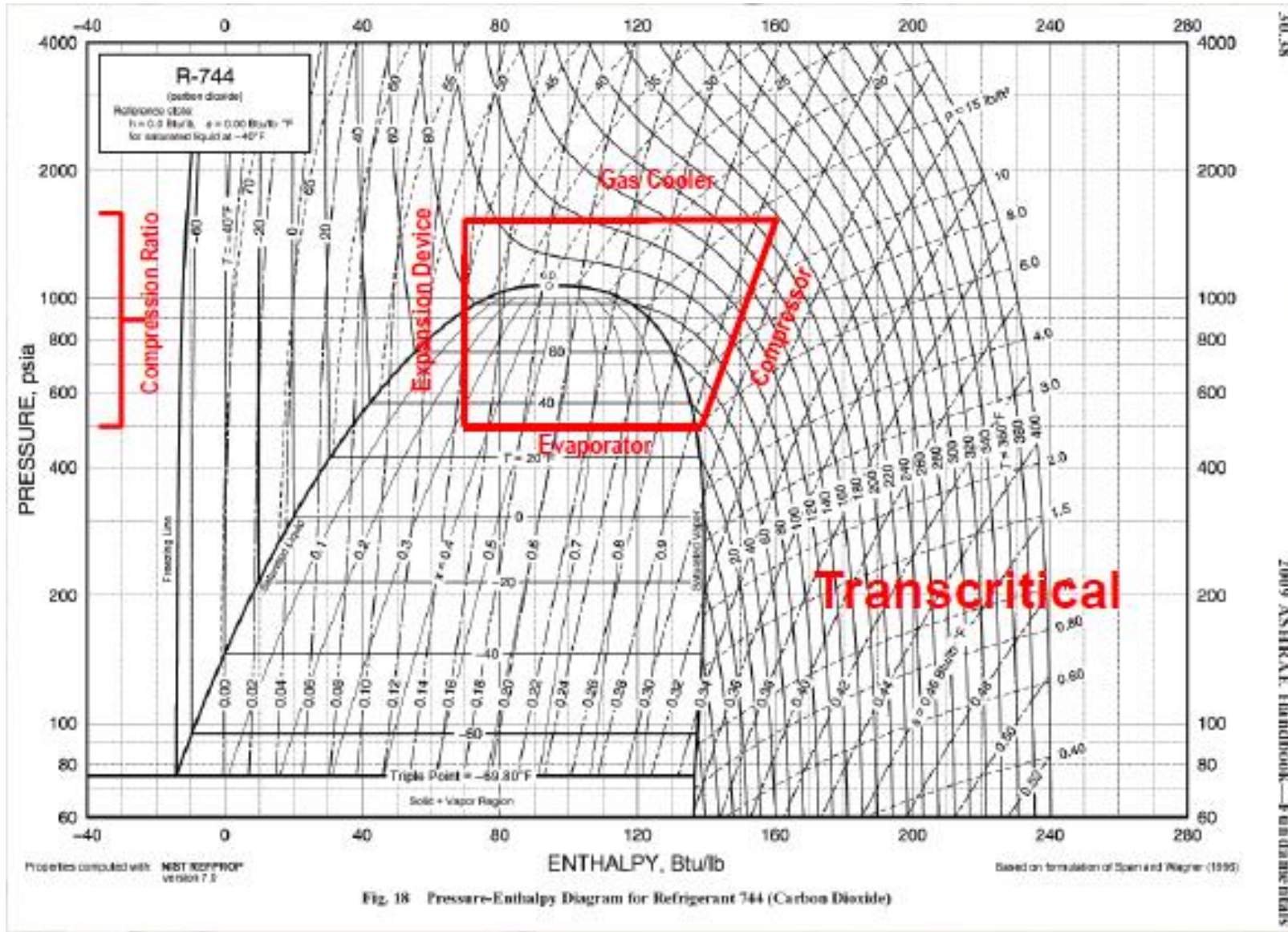

Fig. 18 Pressure-Enthalpy Diagram for Refrigerant 744 (Carbon Dioxide)

Trans-critical Cycle



Work in Which NEEA is a Partner

- Extensive lab testing of packaged and split CO₂ DHW systems (2013 – 2014)
- Field tests of 4 split CO₂ DHW systems (late 2013 to present; one 8,800 DD site in Montana)
- Field tests of 9 combined space & water heating systems (CO₂ split systems, late 2014 to present)
- Lab & field tests of new 11 kW (35 kBtu/hr) combined space & water heating systems (2016/17)

HPWH Performance

— kWh per 100 gallons hot water delivered (@125F)

Note: Performance for CO₂ sites is for cold weather months only; other sites are annual.

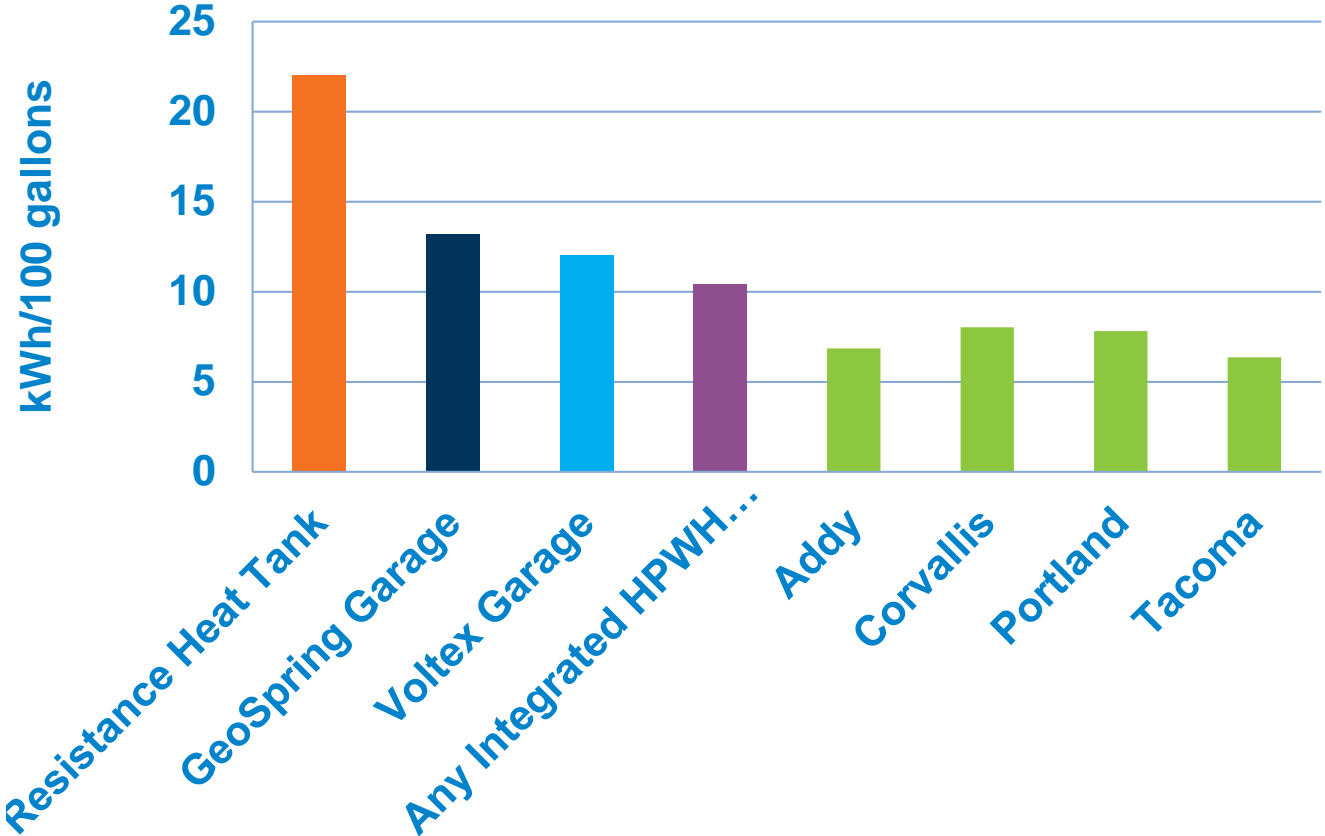

Output

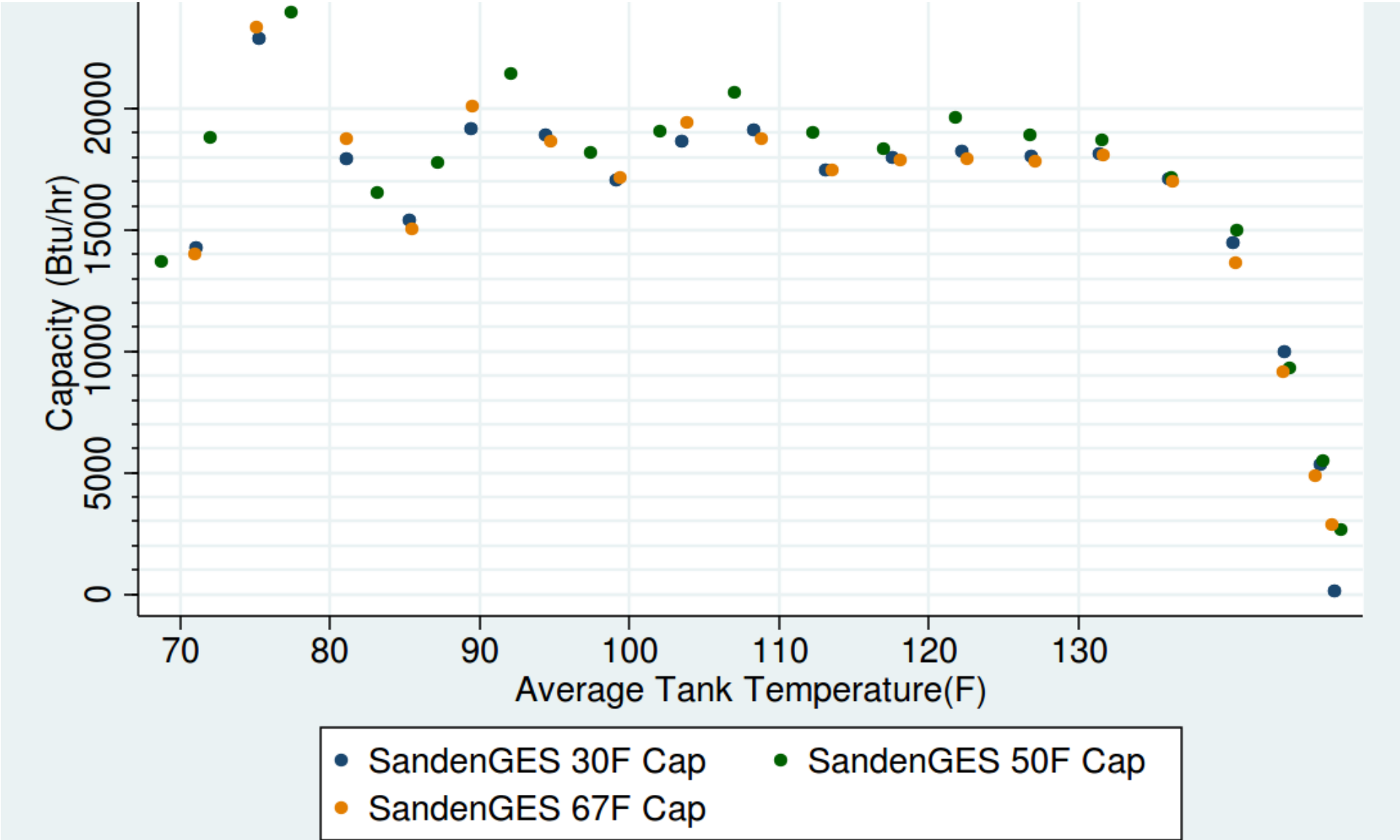

Efficiency

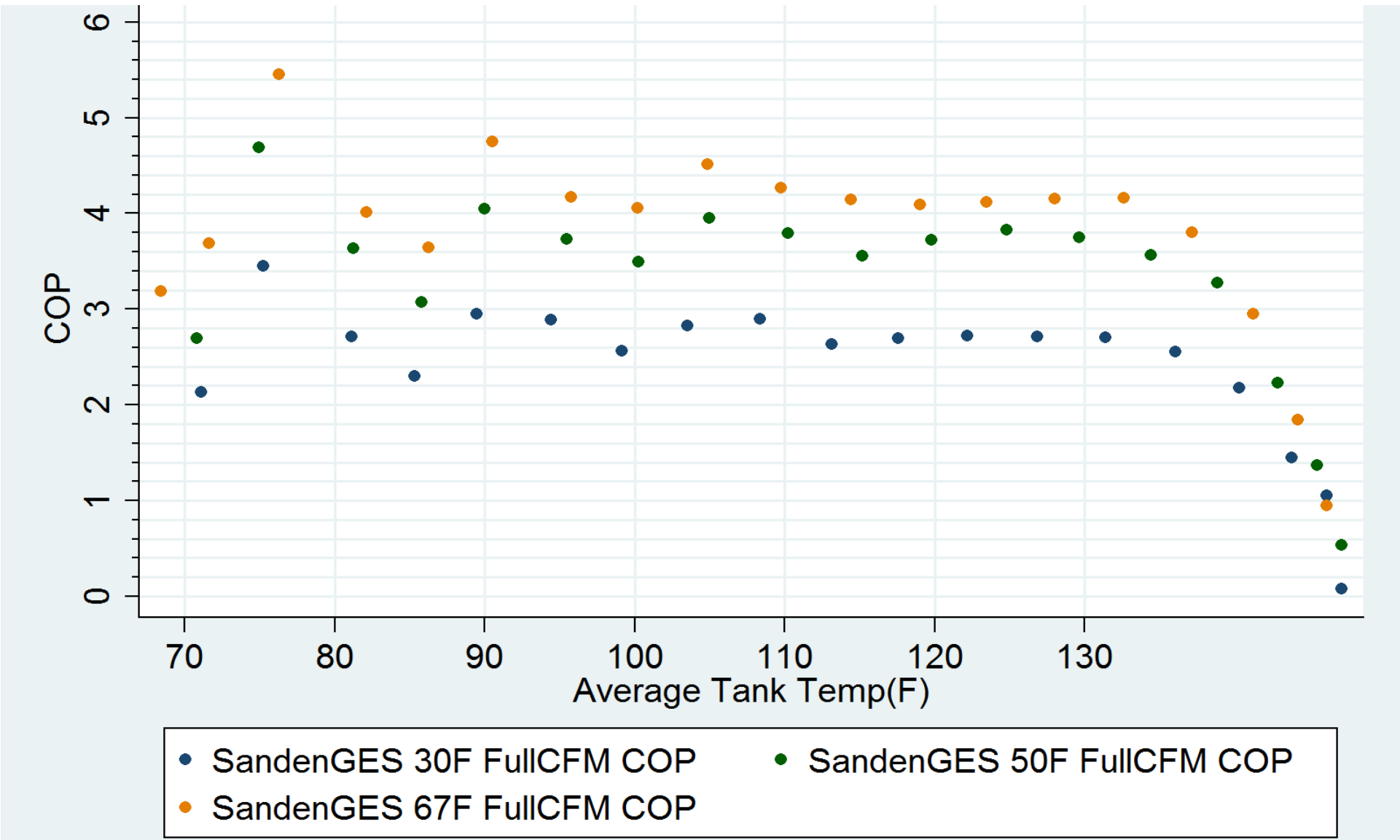

Performance vs. Temperature

Outside Air Temperature (F)	Energy Factor (EF)	COP	Output Capacity (kW)	Input Power (kW)
17	1.74	2.1	4.0	1.9
35	2.21	2.75	3.6	1.3
50	3.11	3.7	4.0	1.1
67	3.35	4.2	4.1	0.97
95	4.3	5.0	4.6	0.93

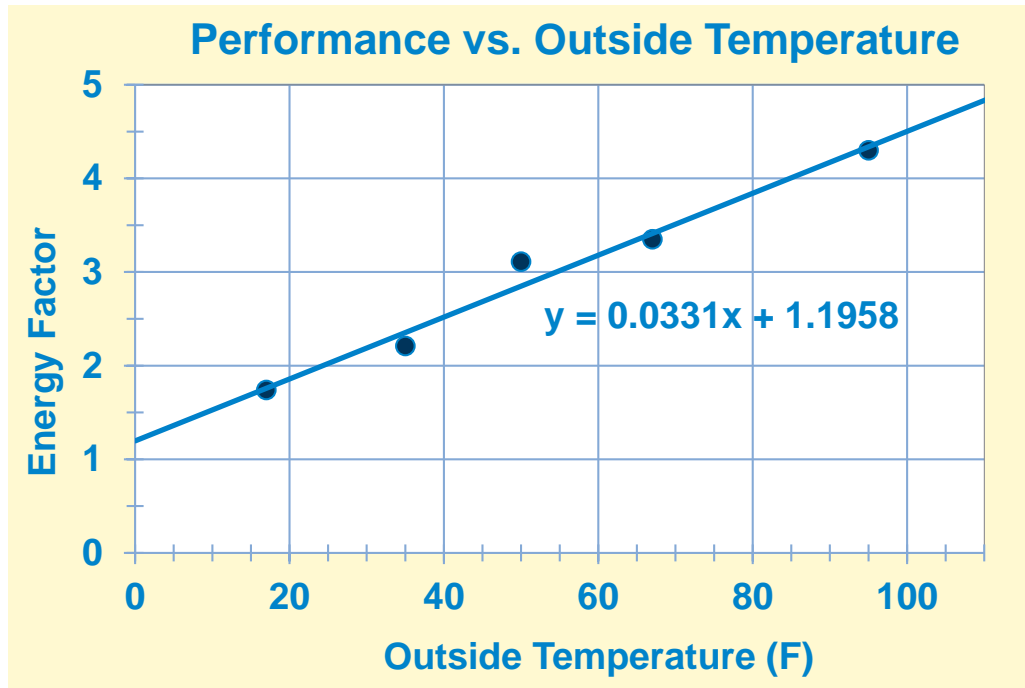

- Linear fit of EF to temperature
- Use TMY temperature bins to calculate an annual EF:

Climate	Annual EF
Boise	2.9
Kalispell	2.6
Portland	3.0
Seattle	2.9
Spokane	2.8



1.25-ton

- UL-listed
- Two tank sizes (40-, 80-gal)
- Available July 2016

3-ton

- In lab-testing phase
- Configured for sp. htg.
- Can do sidearm water heating

System Schematic

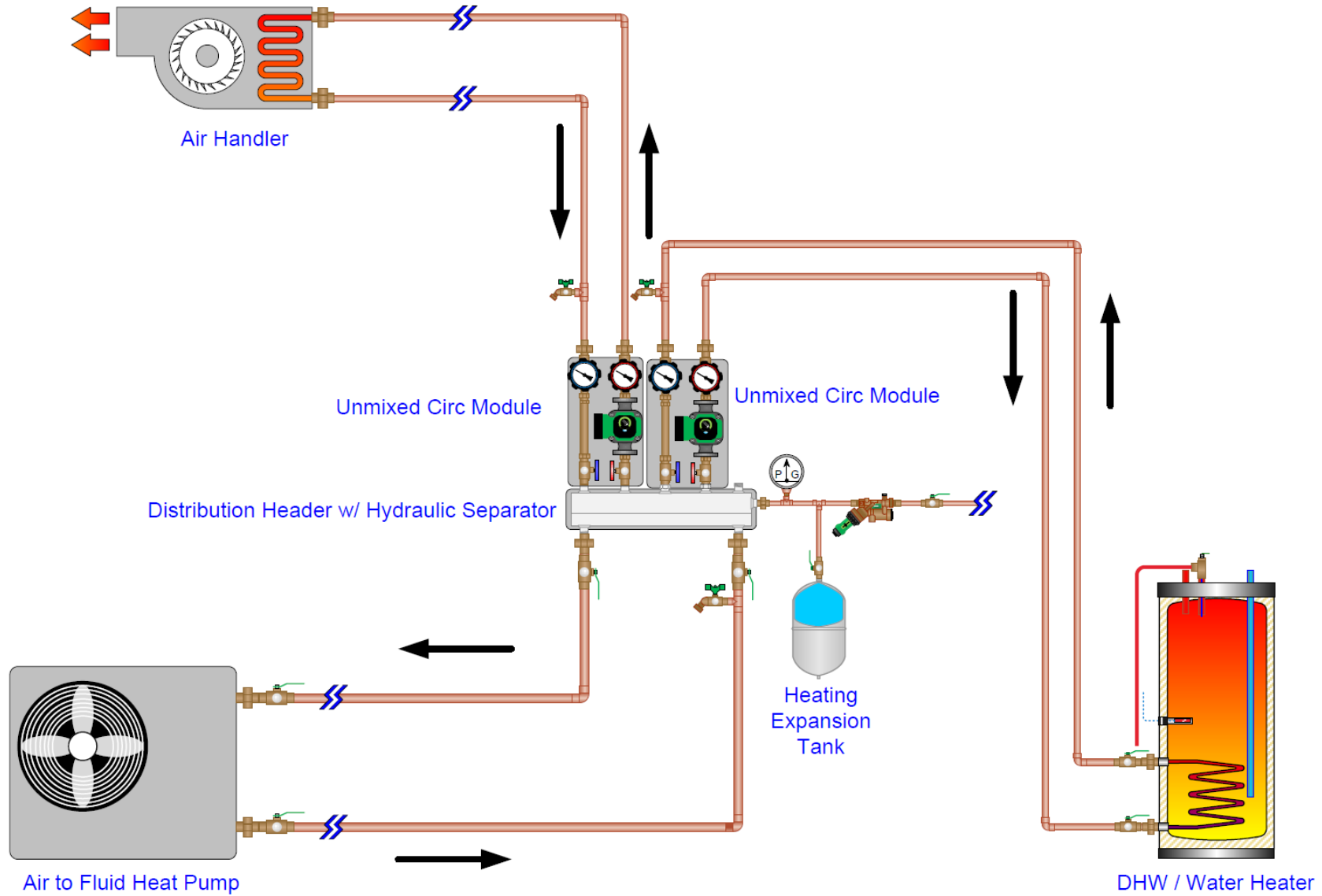

Combined System Configuration

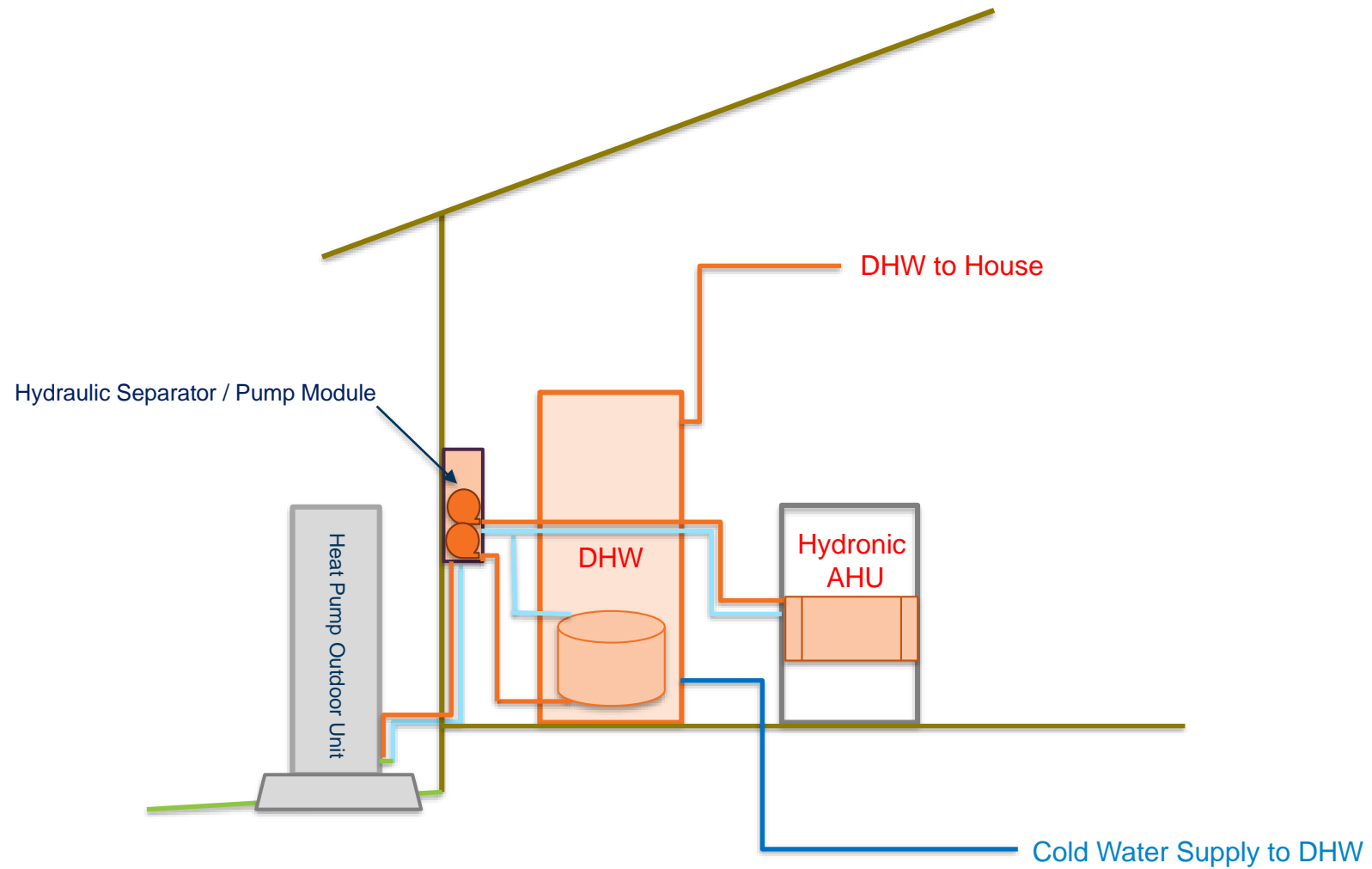

Sanden Eco Runo-based System



Larger Systems



Mayekawa (MYCOM) 22.5-ton air-source system

Larger Systems



Mayekawa 22.5-ton water-source system

Many Applications

Most are industrial or large commercial

Several food processing sites in Quebec & Ontario, winery in CA

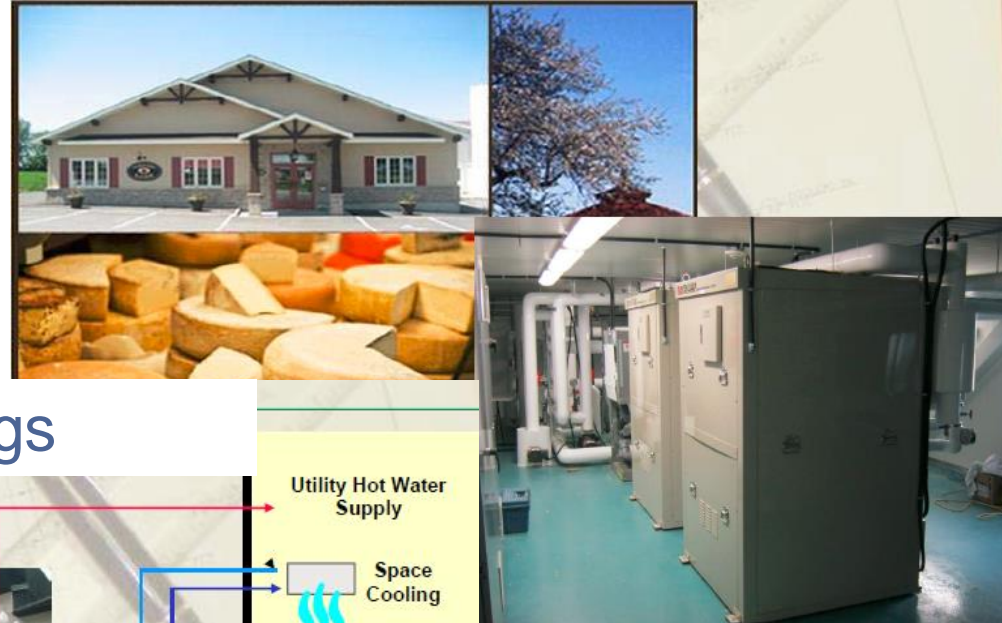

Commercial Buildings

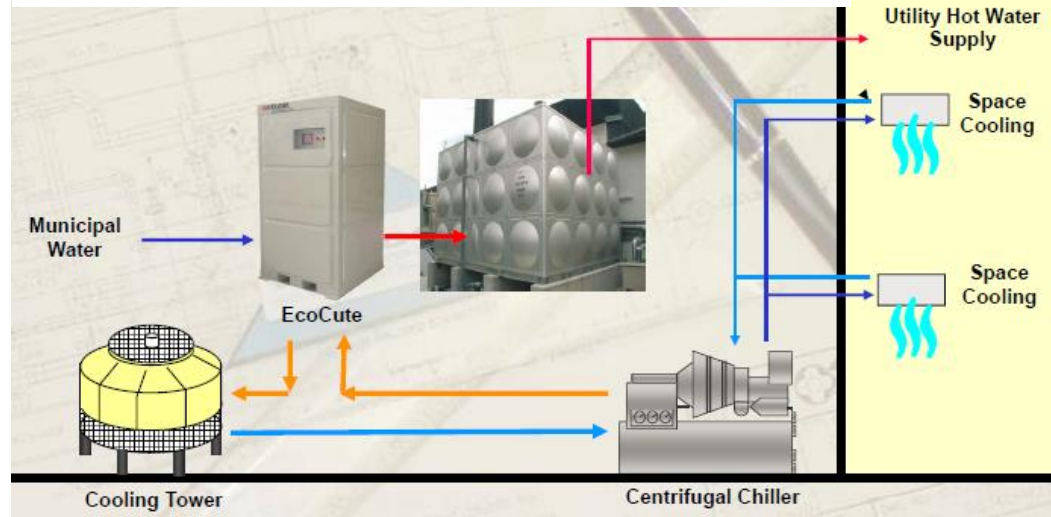

A few takeaways...

- The right refrigerants matter, a lot
- There are energy savings to be had
- This is NOT new technology
 - In common use in Japan, SE Asia for a decade or more; several manufacturers
 - Use in Europe growing rapidly
- UL listing is the largest barrier, by far, to most technologies without a North American presence



Thank you.

Charlie Stephens
cstephens@neea.org
503 688-5457

TOGETHER We Are Transforming the Northwest





Emerging Technologies Summit

Low Capacity Modulating Furnace



*Combining Forces: Next Generation Space Conditioning
and Water Heating Equipment*

2017 ET Summit

Ryan Kerr

Gas Technology Institute

ryan.kerr@gastechnology.org

224.735.0264



Market and EE Drivers

- > Homes with low heating and cooling demand, or low load homes, create new challenges for HVAC system selection and design.
- > The leading edge of the building science community has long asked for a smaller furnace.
- > The need for smaller systems has hit the mainstream with new codes (e.g. IECC 2012/2015), an increased emphasis on MF, whole home weatherization/EE programs, and zero net energy policies.

Technology

- > Heating system: Low capacity furnace
 - 15, 30, 45 MBTU- Modulating 40% to 100%
 - 95% AFUE
 - Quiet Operation, Small footprint
- > Cooling system: Electric heat pump
 - Modulating : 25% to 100%
 - 0.75 to 3 Tons (27-16 SEER)
 - Can do supplemental heating
- > Commercially available
- > Compatible with small-diameter ducts



A 'right' sized modulating HVAC system improves **comfort** and **efficiency** in low load homes through reduced short cycling and high part load efficiencies

Small Diameter Ducts

- > Low, medium velocity
 - Modeling and field test
- > Better throw and mixing
 - Easier, cheaper?
- > Improved duct tightness
 - Easier, cheaper?
- > Easier to integrate into conditioned space, install, and seal

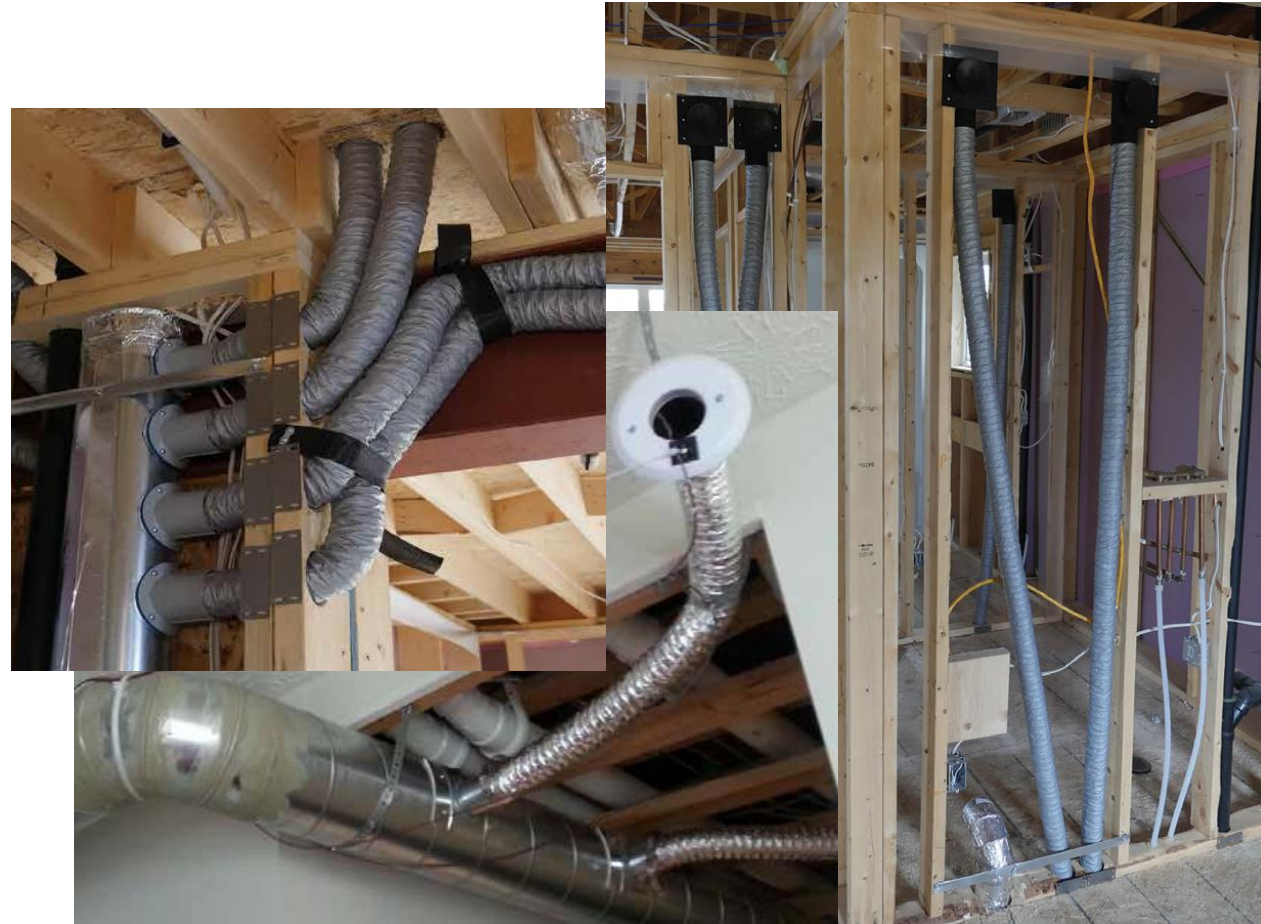

Barriers

- > Quantifying energy and non-energy benefits

- Energy Savings

- > Modulation
 - > Sizing
 - > Small diameter ducts
 - > Heat pump

- Non-energy Benefits

- > Installed cost
 - > Comfort, call-backs

- > Applying savings: energy models and prescriptive (AFUE)



Active Projects

- > NYSERDA: 5 units in Syracuse, NY (furnace + heat pump)
 - Low-income, post-retrofit monitoring
- > CEC/SoCal Gas: 5 homes in SoCal (furnace + heat pump)
 - Single-family, pre- and post-monitoring
- > IL DCEO: 7 units in Rockford, IL (furnace + heat pump)
 - Low-income, post-retrofit monitoring
- > NWN: 6 homes in Oregon (furnace only)
 - Low-income, post-retrofit surveys (no monitoring)
- > NEEA: Laboratory performance profiling
 - Initial results indicate improved part load performance with modulating furnace vs. 1 and 2 stage

Report Out and Wrap Up

- What are the critical barriers that need to be addressed for this technology to realize its potential?
- What are the milestones along the way that would indicate it's time to address each barrier?
- What opportunities are there to work together to address those barriers? What competencies are needed to address the barriers?

